

WALTHER PILOT

Betriebsanleitung / Operating Instructions /
Instructions de Service / Gebruiksaanwijzing

D GB F NL

PILOT Signier

Signierpistole / Marking Gun /
Pistolet de Marquage / Markeer Spuitpistolen

Typ / Type

20 360



REV. 10/11



Die Beschichtungs-Experten

PILOT Signier 20 360

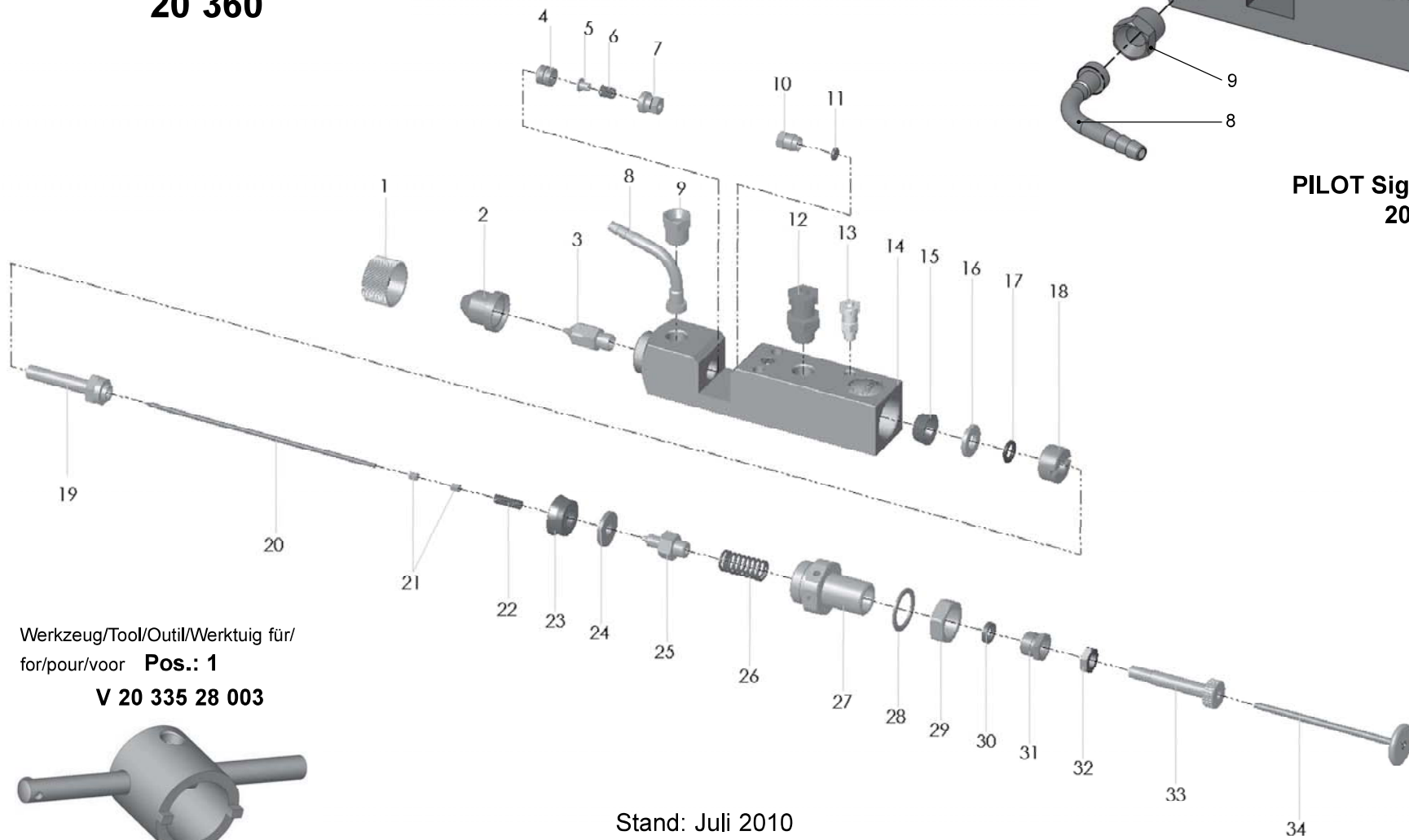

PILOT Signier Umlauf 20 361

Werkzeug/Tool/Outil/Werktuig für/
for/pour/voor **Pos.: 1**
V 20 335 28 003

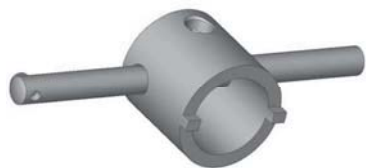

Stand: Juli 2010

Maßblatt / Dimension Sheet / Mesures / Maataanduiding

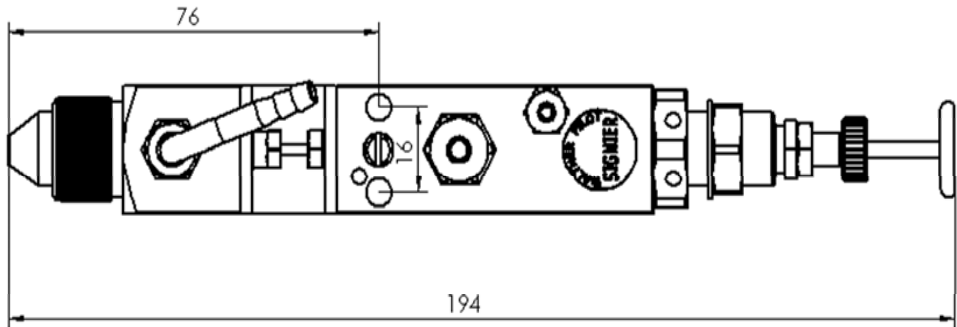
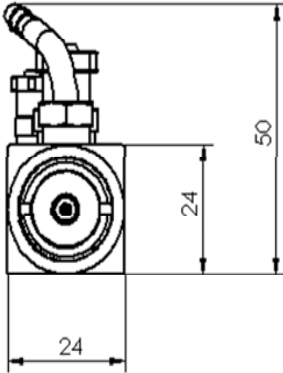
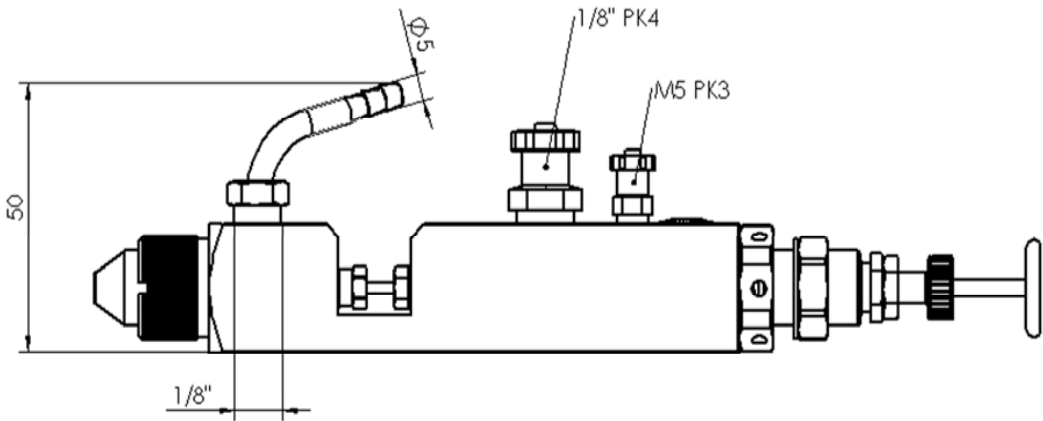

Listing of Contents

	Exploded Drawing	2
	Dimension Sheet	4
	Declaration of CE-Conformity	25
	List of Replacement Parts	26
1	General	28
1.1	Identification of Model Version	28
1.2	Normal Use	28
1.3	Improper Use	29
2	Technical Description	29
3	Safety Warnings	30
3.1	Safety Warning Symbols	30
3.2	General Safety Precautions	30
4	Assembly / Installation	31
4.1	Mounting of Spray Gun	31
4.2	Connection of Input Lines	31
5	Operational Handling	32
5.1	Safety Warnings	32
5.2	Starting/Stopping Requirements	32
5.3	Spray Pattern Test	32
5.4	Correction of Spray Pattern Imperfections	33
5.5	Retooling of Spray Gun	34
6	Cleaning	34
6.1	Safety Warnings	34
6.2	Cleaning - Complete	35
6.3	Cleaning - Routine	35
7	Repairs / Replacements	36
7.1	Replacement of defective Needle Seal Packings	36
7.2	Replacement of Nozzles, Needles, Springs and Seals	37
8	Troubleshooting and Corrective Action	37
9	Disposal of Cleaning / Servicing Substances	38
10	Specification Data	38



Declaration of CE-Conformity



We, the manufacturers of the equipment, hereby declare under our sole responsibility that the product(s) described below conform to the essential safety requirements. This declaration will be rendered invalid if any changes are made to the equipment without prior consultation with us.

Manufacturer	WALTHER Spritz- und Lackiersysteme GmbH Kärntner Str. 18 - 30 D - 42327 Wuppertal Tel.: +49(0)202 / 787 - 0 Fax: +49(0)202 / 787 - 2217 www.walther-pilot.de • e-mail: info@walther-pilot.de		
Type Designation	Automatic Spray Gun PILOT Signier 20 360	V 20 360	
Intended purpose	Processing of sprayable media		
Applied Standards and Directives			
EU-Mechanical Engineering Directives 2006 / 42 / EC 94 / 9 EC (ATEX Directives) DIN EN ISO 12100-1 DIN EN ISO 12100-2 DIN EN 1127-1			
DIN EN 1953 DIN EN 13463-1			
Specification according 94 / 9 / EC			
Category 2	Part marking		Tech.File,Ref.: 2408
Authorized with the compilation of the technical file: Nico Kowalski, WALTHER Spritz- und Lackiersysteme GmbH, Kärntner Str. 18 - 30 D- 42327 Wuppertal			
Special remarks : The named product is intended for installation in other equipment. Commissioning is prohibited until such time as the end product has been proved to conform to the provision of the Directives 2006 / 42 / EC.			

Wuppertal, the 1st of January 2010

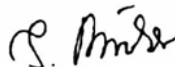

i.v. 

Name: Torsten Bröker
Position: Manager, Design and Development

This Declaration does not give assurance of properties in the sense of product liability. The safety instructions provided in the product documentation must be observed at all times.

List of replacement parts:					
		Pilot Signier		PILOT Signier circulation	
		V 20 360		V 20 361	
Item	Description	Qty.	Article-No.	Qty.	Article-No.
1	Air cap nut	1	V 20 335 15 000	1	V 20 335 15 000
2	air cap ◀	1	V 20 336 xx xxx*	1	V 20 336 xx xxx*
3	Material nozzle	1	V 20 336 23 xx3*	1	V 20 336 23 xx3*
4	Needle seal packing	1	V 09 002 41 000	1	V 09 002 41 000
5	Spring cup	1	V 20 353 14 000	1	V 20 353 14 000
6	Spring	1	V 20 353 04 000	1	V 20 353 04 000
7	Stuffing box	1	V 20 353 03 003	1	V 20 353 03 003
8	Hose fitting	1	V 20 336 31 320	2	V 20 336 31 320
9	Cap screw	1	V 20 336 33 005	2	V 20 336 33 005
10	Stuffing box screw plug	1	V 20 335 11 003	1	V 20 335 11 003
11	O-ring	1	V 09 103 02 000	1	V 09 103 02 000
12	Quick-release fitting	1	V 66 100 02 027	1	V 66 100 02 027
13	Quick-release fitting	1	V 66 100 03 561	1	V 66 100 03 561
14	Gun body	1	V 20 360 01 005	1	V 20 361 01 005
15	Cup seal	1	V 09 210 09 000	1	V 09 210 09 000
16	Sealing washer	1	V 20 335 09 000	1	V 20 335 09 000
17	O-ring	1	V 09 102 12 001	1	V 09 102 12 001
18	Piston sealing screw	1	V 20 335 08 000	1	V 20 335 08 000
19	Piston	1	V 20 335 06 000	1	V 20 335 06 000
20	Material needle	1	V 20 335 20 . . 3*	1	V 20 335 20 . . 3*
	Material needle Carbide metal	1	V 20 335 29 . . 0*	1	V 20 335 29 . . 0*
21	Needle-nut	2	V 10 106 02 000	2	V 10 106 02 000
22	Needle-spring	1	V 10 106 04 000	1	V 10 106 04 000
23	Cup seal	1	V 09 210 08 000	1	V 09 210 08 000
24	Piston-disc	1	V 20 335 10 000	1	V 20 335 10 000
25	Piston-screw	1	V 20 335 07 000	1	V 20 335 07 000
26	Valve spring	1	V 10 106 08 000	1	V 10 106 08 000
27	Spring retaining bush	1	V 20 336 35 000	1	V 20 336 35 000
28	Washer	1	V 20 666 06 000	1	V 20 666 06 000
29	Hexagonal nut	1	V 20 660 04 003	1	V 20 660 04 003
30	Clamping ring	1	V 20 336 36 000	1	V 20 336 36 000
31	Stuffing box	1	V 10 501 06 000	1	V 10 501 06 000
32	Counternut	1	V 20 336 45 000	1	V 20 336 45 000
33	Adjusting screw	1	V 20 336 37 000	1	V 20 336 37 000
34	Pull bar compl.	1	V 20 336 38 390	1	V 20 336 38 390
35	Sealing washer			1	V 20 339 32 009
36	Screw plug			1	V 20 330 03 003

Repair kit	
WALTHER PILOT supplies repair kit containing all wearing parts for the automatic spray gun PILOT Signier and Pilot Signier-Circulation. This parts are shown in bold print in the list.	
	Article-No.
PILOT Signier / -circulation	V 16 120 51 XX3

◀ Air caps optional:		
	Size	Article-No.
Round jet air cap 	0,3 / 0,5 mm ø	V 20 336 34 035*
	0,8 / 1,0 mm ø	V 20 336 34 085*
	1,2 / 1,5 mm ø	V 20 336 34 125*
Flat jet air cap 	0,3 / 0,5 mm ø	V 20 336 44 032*
	0,8 / 1,0 mm ø	V 20 336 44 082*
	1,2 / 1,5 mm ø	V 20 336 44 122*
Flat jet air cap 	0,3 / 0,5 mm ø	V 20 336 50 035*
	0,8 / 1,0 mm ø	V 20 336 50 085*
	1,2 / 1,5 mm ø	V 20 336 50 125*

Nozzle sets		
Nozzle sets consist of air cap, material nozzle and material needle.		
	Article-No.	Air cap variant
PILOT Signier / -circulation	V 15 120 51 XX3	V 20 336 34 XX5
	V 15 120 01 XX3	V 20 336 44 XX2
	V 15 120 02 XX3	V 20 336 50 XX5

Nozzle sizes optional:

0,3 ▪ 0,5 ▪ 0,8 ▪ 1,0 ▪ 1,2 ▪ 1,5 mm ø

* Please quote the required size(s) when placing an order for replacement parts. It is recommended to keep in stock all BOLD-faced parts (fast wearing parts).

1 General

1.1 Identification of Model Version

Model: Automatic Spray Gun PILOT Signier 20 360

Type Series: V 20 360

Manufacturer: WALTHER Spritz-und Lackiersysteme GmbH
Kärntner Str. 18-30
D-42327 Wuppertal
Tel.: 00 49 202 / 787-0
Fax: 00 49 202 / 787-2217
www.walther-pilot.de • Email: info@walther-pilot.de

1.2 Normal Use

The automatic spray gun PILOT Signier is exclusively designed for use with sprayable materials, especially:

- paints and lacquers
- greases, oils and corrosion preventives
- adhesive compounds
- ceramic glazes
- pickling solutions

Aggressive media should generally not be sprayed. If your specific material is not listed above, please contact us for further and detailed information.

Please note that sprayable material may only be applied to workpieces and/or similar items. The model PILOT Signier is not designed for manual operation and must therefore be installed in a suitable gun mounting device.

The temperature of the spraying material shall never exceed 80 degs. C. The term normal use also implies that any and all safety warnings, operational handling details, etc., as stated in these Operating Instructions, are carefully read, understood and duly complied with.

This equipment complies with the explosion protection requirements of Directive 94 / 9 / EC (ATEX) for the explosion group, equipment category and temperature class indicated on the type plate.

When using the equipment, the requirements specified in these Operating Instructions must be observed at all times.

The technical data indicated on the equipment rating plates and the specifications in the chapter "Technical Data" must be complied with at all times and must not be exceeded. An overloading of the equipment must be ruled out.

The equipment may be used in potentially explosive atmospheres only with the authorisation of the relevant supervisory authority.

The relevant supervisory authority or the operator of the equipment are responsible for determining the explosion hazard (zone classification).

The operator must check and ensure that all technical data and the marking of the equipment in accordance with ATEX are compliant with the necessary requirements.

The operator must provide corresponding safety measures for all applications in which the breakdown of the equipment might lead to danger to persons. If any irregularities are observed while the equipment is in operation, the equipment must be put out of operation immediately and WALTHER Spritz- und Lackiersysteme must be consulted.

Grounding / Equipotential Bonding

You must ensure that the spray gun is properly earthed (grounded) either separately or in connection with the equipment with which it is being used (maximum resistance $10^6\Omega$).

1.3 Improper Use

This spray gun shall not be used for purposes other than set forth in the above Chapter 1.2 *Normal Use*.

Any other form of use and/or application is prohibited.

The term improper use also includes such operations as:

- spraying of material onto persons and animals
- spraying of liquid nitrogen

2 Technical Description

The model PILOT Signier is an all-automatic air-controlled gun operating in combination with a 3/2-way control valve in the form of hand-, foot- or solenoid-actuated valves.

Actuation of the 3/2-way valve directs control air into the cylinder inside the gun so as to open - in sequence - the atomizing air and the material input.

Closing of the 3/2-way valve is followed by the control air escaping from the cylinder inside the gun, upon which the spring-loaded material control needle returns to its initial position, where it shuts the material and atomizing air input off.

The material inlet duct of the PILOT Signier can be opened manually so as to permit, for example, cleaning of a clogged material outlet nozzle.

3 Safety Warnings

3.1 Safety Warning Symbols

 **Warning**
This pictograph and the accompanying warning note „**Warning**“ indicates possible risks and dangers for yourself and others.
Possible consequences: injuries of any kind.

 **Caution**
This pictograph and the accompanying warning note „**Caution**“ indicates possible damage to equipment.
Possible consequences: damage to equipment.

 **Notice**
This pictograph and the accompanying note „**Notice**“ indicates additional and useful information to help you to handle the spray gun with even greater confidence and efficiency.

3.2 General Safety Precautions

- It is important that all applicable accident prevention directives as well as industrial safety and health rules and regulations are duly complied with.
- Use this spray gun in well ventilated rooms. Open fires, naked lights and smoking are prohibited in the working area. Spraying of readily flammable media such as paints, lacquers, cleaning agents, etc., causes a potential health, explosion and fire risk.
- You must ensure that the spray gun is properly earthed (grounded) either separately or in connection with the equipment with which it is being used (max. resist. 10⁶Ω).
- Prior to any servicing and repair work: Make sure that the spray gun is in unpressurized condition, i.e. all air and material inputs must be shut off - if not, imminent risk of injury.
- Keep your hands and other extremities away from the front of the spray gun - imminent risk of injury.
- Never point the spray gun at persons or animals - imminent risk of injury.
- It is important that all processing specifications and safety warnings issued by the manufacturers of spraying and cleaning media are duly complied with. Aggressive and corrosive media represent risk and hazards to personal health.
- The spray guns can produce sound levels of up to about 83 dB (A). It is therefore important to wear suitable hearing protectors.
- Air-borne particles represent a health hazard and must therefore be kept away from the working area. Wear proper respiratory protection masks and protective overalls when working with spraying media. Air-borne particles represent a health hazard.
- Nuts, screws and fasteners are always likely to come loose; therefore it is important to ensure that they are properly tightened, especially after servicing and repair work.
- Make sure you use only original WALTHER replacement parts designed for functional reliability and efficiency.

- Should you have any further questions regarding the safe use of the spraying gun please contact WALTHER Spritz- und Lackiersysteme GmbH, Wuppertal.

4 Assembly / Installation

This spray gun is delivered in completely assembled condition. Before taking it into operation, perform the following preparations:

4.1 Mounting of Spray Gun

Install the gun in a suitable and stable mounting device. Use both \varnothing 5 mm mounting bores.

4.2 Connection of Input Lines

 **Warning**
Make sure not to confuse the control and atomizing air connections - Risk of Injury.

1. Connect the input line for

- spraying air to the inlet fitting of the gun (G 1/8" - PK 4), marked with (1)
- control air to the inlet fitting of the gun (M5 - PK 3), marked with (2)
- the material supply to the inlet fitting of the gun (G 1/8" - 5 mm \varnothing) marked with (3)

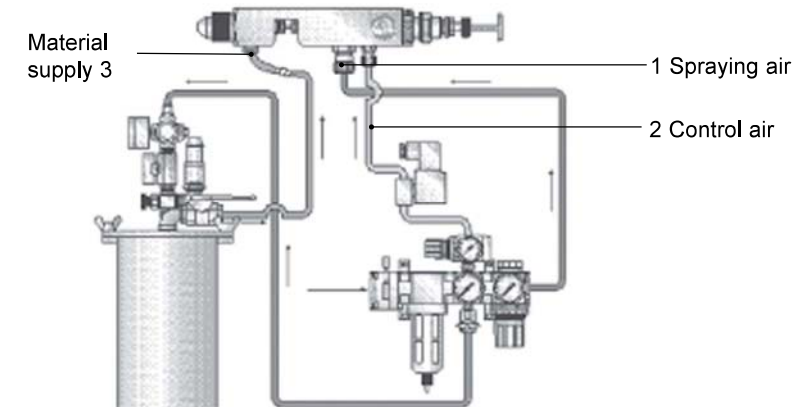

2. Check the hoses for tightness.

The spray gun is now properly installed and connected and ready for operation.

5 Operational Handling

5.1 Safety Warnings

Pay special attention to the following safety warnings prior to taking the spray gun into operation!

- Wear proper respiratory protection masks and protective overalls whenever operating this spray gun. Air-borne particles represent a health hazard.
- Wear suitable hearing protectors. Spray guns produce sound levels of up to 83 dB (A), which are very likely to cause hearing defects.
- Open fires, naked lights and smoking is prohibited in the working area. Spraying of readily flammable media (such as laquers, adhesive compounds) is always accompanied by the increasing risk of fire and explosion.

5.2 Starting / Stopping Requirements

The following requirements must be met, before this spray gun can be taken into operation:

- the control pressure must be available at the gun.
- the atomizing air pressure must be available at the gun.
- the material pressure must be available at the gun.



Caution

The material pressure shall not exceed

- 6 bar, as, otherwise, the functional reliability of the spray gun will suffer. Adjust the control air pressure to
- at least 4 bar, in order to operate the spray gun.

High switching frequencies can loosen the pull bar (item 34). Always remove the draw bar before taking the machine into operation.



Warning

It is important to remember that the spray gun must be relieved of all pressures whenever work is terminated. Lines left in pressurized condition could burst, with their contents likely to injure anybody present nearby.

5.3 Spray Pattern Test

Spray pattern tests should be performed whenever:

- the spray gun is taken into operation for the 1st time.
- the spraying medium is changed.
- the spray gun was taken apart for servicing or repairs.

The spray pattern is best tested using a workpiece sample, a sheet of metal, cardboard or paper.



Warning

Keep your hands and other extremities away from the front of the spray gun - imminent Risk of Injury.



Warning

Make sure that nobody is present in the spraying zone when the gun is started - imminent Risk of Injury.

1. Start the gun to produce a spray pattern sample (see 5.2 *Starting/Stopping Requirements*).
2. Inspect the sample and readjust the settings of the gun if necessary.

Adjustment of the Material Flow Rate

The material flow rate can be adjusted by using the adjusting screw (item 33). Screwing in the adjusting screw reduces the material rate; screwing out increases the material rate.

Adjustment of the Material Pressure

This adjustment can only be made at the pump or the pressurized tank. Observe the Operating Instructions and Safety Warnings issued by the manufacturer.

Adjustment of the Atomizing Air Pressure

The atomizing air pressure is to be adjusted at the air pressure reducing valve of the compressor system. Observe the Operating Instructions and Safety Warnings issued by the manufacturer.

5.4 Correction of Spray Pattern Imperfections

The following table shows how to correct a defective spray pattern.



desired spray result

Spray pattern test	Fault	Required adjustment
	Spray pattern is split in the centre	• setting a wider spray pattern
	Spray pattern is too thick at the ends	• Setting a more rounded spray pattern
	The spray pattern shows rather large droplets	• Increase the nozzle air pressure
	Material application in the centre of the spray pattern is very thin	• Decrease the nozzle air pressure
	Spray pattern is split in the centre	• Increase the nozzle diameter • Reduce nozzle air pressure • Increase material pressure
	Spray pattern is very spherical	• Reduce material pressure • Increase nozzle air pressure

5.5 Retooling of Spray Gun

Combinations of air cap, material nozzle + needle, designed to match specific spraying media types and grades, form a unit - namely the nozzle insert assembly, which must always be interchanged as a complete assembly to maintain the desired spray-finish quality standard.



Warning

Prior to retooling: make sure that the spray gun is in unpressurized condition, i.e. all air and material inputs must be shut off - if not, imminent Risk of Injury.



Notice

Please use the drawing (page 2) and the list of replacement parts (page 26) of these Operating Instructions in order to perform the operating steps presented hereafter.

Replacement of Material Nozzle and Needle

1. Unscrew the air cup nut (item 1) and the air cap (item 2).
2. Unscrew the material nozzle (item 3) and the spring retaining bush (item 27) from the gun body (item 14) (SW 9 a. SW 22).
3. Pull out the complete needle insert from the gun body.
4. Unscrew the pull bar (item 34) from the piston (item 19).
5. Remove the valve spring (item 26).
6. Unscrew the piston-screw (item 25) from the piston.
7. Remove the piston-disk (item 24), the cup seal (item 23) and the needle-spring (item 22).
8. Pull out the material needle (item 20) from the piston.
9. Screw out both needle-nuts from the needle (item 21) (SW 3).

Installation of the new material nozzle and needle is performed in reverse order.



Notice

The slip gauge of the material needle is 96 mm from the needle tip to the first needle-nut.



Notice

Apply a thin film of grease to the following components during assembly: cup seal (item 23), valve spring (item 26).

6 Cleaning

6.1 Safety Warnings

- Make sure that the spray gun is in unpressurized condition, i.e. all air and material inputs must be shut off - if not, imminent Risk of Injury.
- Open fires, naked lights and smoking is prohibited in the working area. There is an increasing risk of fire and explosion, when spraying readily flammable media (such as cleaning solutions).
- Observe all processing specifications and safety warnings issued by the manufacturer of cleaning media. Especially aggressive and corrosive media represents risks and hazard to personal health.

6.2 Cleaning - Complete

The spray gun should be frequently cleaned and lubricated so as to ensure a long service life and functional reliability.

Clean the gun only with cleaning solutions recommended by the manufacturer of the spraying material, which do not contain any of the following constituents:

- halogenated hydrocarbons (e.g. 1,1,1, trichloroethane; methylene chloride, etc.)
- acids and acidiferous cleaning solutions
- regenerated solvents (so-called cleaning dilutions)
- paint removers

The above constituents cause chemical reactions with electroplated components resulting in corrosion damage.

WALTHER Spritz- und Lackiersysteme is not responsible for damages resulting from this kind of treatment.

Clean the spray gun

- prior to each change of the spraying medium
- at least once a week
- as often as may be required by the spraying medium handled and the resulted degree of fouling.



Caution

Never immerse the spray gun in solvent or any other cleaning solution as such measure is very likely to affect the functional reliability and efficiency of the gun.



Caution

Do not use any hard, pointed or sharp-edged objects when cleaning the spray gun, as the precision-made parts can be easily damaged and are likely to affect your spraying results.

1. Dismantle the spray gun according to 5.5 *Replacement of Material Nozzle and Needle*
2. Use a soft brush together with a compatible cleaning solution to clean the air cap and material nozzle
3. Use a suitable cloth with a compatible cleaning solution to clean the gun body and all remaining parts
4. Apply a thin layer of grease to the following parts:
 - cup seal (item 23)
 - valve spring (item 26)

Make sure to use a non-acidic, non-resinogenic grease and apply this with a soft brush. Assemble the spray gun in reverse order.

6.3 Cleaning - Routine

The spray gun does not have to be necessarily dismantled for cleaning if and when the spraying medium is changed in regular intervals or upon termination of work (depending, of course, on the material used).

**Notice**

It is recommended to clean and lubricate the spray gun frequently in accordance with 6.2 *Cleaning - Complete*. This will ensure a functional reliability of the spray gun.

The following requirements must be met before the routine cleaning work can be performed:

1. The material tank must be clean and then be filled with a compatible cleaning solution. The material pressure must be available at the gun. The cleaning solution should never be sprayed.
2. Take the spray gun into operation (see 5.2 *Starting / Stopping Requirements*).
3. Do not stop the spray gun until clear cleaning solution emerges from the nozzle.

The material input of the PILOT Signier can be released manually so that the complete spraying system does not have to be taken into operation.

1. Pull the draw bar (item 34) of the spray gun backwards. The material inlet is now open and both the material duct and the material needle will be cleaned.
2. Do not let go of the draw bar until clear cleaning solution emerges from the spray gun.

All pressures should be removed from the complete spraying system until it is taken into operation again.

7 Repairs / Replacements

**Warning**

Prior to any repairs / replacements: Make sure that the spray gun is in unpressurized condition, i.e. all air and material inputs must be shut off - if not, imminent Risk of Injury.

**Notice**

Please use the drawing (page 2) and the listing of replacement parts (page 26) of these Operating Instructions in order to perform the following operating procedures.

7.1 Replacement of defective Needle Seal Packings

1. Remove all pressures from the spray gun.
2. Remove the material needle according to 5.5 *Retooling the Spray Gun*.
3. Remove the stuffing box (item 7) from the gun body (SW 7).
4. Pull out the spring cup (item 5) and the spring (item 6) from the gun body (replace, if damaged).
5. Remove the needle seal packing (item 4) from its seat. Use a strong wire with one end bent to form a small hook.
6. Lubricate the new needle seal packing with a non-acidic, non-resinogenic grease.
7. Install the new needle seal packing in the gun body.

Installation of the remaining parts is performed in reverse order.

**Notice**

Never reinstall the removed needle seal packing (item 4) to the gun front attachment; otherwise, the functional sealing reliability of the spray gun will suffer.

7.2 Replacement of Nozzles, Needles, Springs and Seals

Dismantle the spray gun in accordance to 5.5 *Retooling the Spray Gun* if any of the following parts have to be replaced:

- Material nozzle
- Valve spring*
- Material needle
- Needle-spring
- Cup seal*

**Notice**

Parts marked * must be lubricated with a non-acidic, non-resinogenic grease prior to installation.

**Notice**

WALTHER Spritz- und Lackiersysteme supplies repair kit containing all wearing parts for the automatic spray gun PILOT Signier 20 360. This parts are shown in bold print in the list:

Article-No.: V 16 120 51 . . 3

8 Troubleshooting and Corrective Action

**Warning**

Prior to any servicing and repair work: Make sure that the spray gun is in unpressurized condition, i.e. all air and material inputs must be shut off - if not, imminent Risk of Injury.

Fault	Cause	Remedy
Gun is dripping	Material needle or nozzle is fouled	see 5.5 <i>Retooling the Spray Gun</i> , replace and clean
	Material needle or nozzle is damaged	see 7.2 <i>Replacement of Nozzle or Needle</i>
	Stuffing box (item 7) is too tight	Loosen stuffing box slightly with a screw wrench 7
Gun fails to open	Control air pressure too low	Increase control air pressure to at least 4 bar
Spray jet pulsating or unsteady	Level in material tank too low	Top-up material level (see Operating Instructions of plant systems manufacturer)
Gun sprays when not in operation	Cup seals (item 15 or item 23) are damaged	Replace

9 Disposal of Cleaning / Servicing Substances

Disposal of any such substances must be in accordance with all applicable local and national regulations, directives and laws.



Warning

Pay special attention to all processing specifications and warnings issued by the manufacturer of spraying and cleaning media. The improper disposal of any toxic waste material represents a serious threat to the environment, i.e. to the health of mankind and animal life.

10 Specification Data

Weight:	500 g
Connections:	
Atomizing Air	G 1/8"
Control Air	M 5
Material Inlet	G 1/8"
Pressure Ranges:	
Atomizing Air Pressure	see table
Control Air Pressure	max. 6 bar
Material Pressure	max. 6 bar
max. Operating Temperature of Spray Gun	80° C
Sound Level (measured at a distance of 1 m from the spray gun)	83 dB(A)
Air Consumption:	
1 bar Atomizing Air Input	20 l / min.
2 bar Atomizing Air Input	30 l / min.
3 bar Atomizing Air Input	40 l / min.
4 bar Atomizing Air Input	50 l / min.
5 bar Atomizing Air Input	60 l / min.
6 bar Atomizing Air Input	80 l / min.

Right to effect technical changes reserved.

Das WALTHER PILOT-Programm

- Hand-Spritzpistolen
- Automatik-Spritzpistolen
- Niederdruck-Spritzpistolen (System HVLP)
- Pulverbeschichtungs-Systeme
- Materialdruckbehälter
- Drucklose Behälter
- Rührwerk-Systeme
- Airless-Geräte und Flüssigkeitspumpen
- Materialumlaufsysteme
- Kombinierte Spritz- und Trockenboxen
- Absaugsysteme mit Trockenabscheidung
- Absaugsysteme mit Nassabscheidung
- Pulversprühstände
- Trockner
- Zuluft-Systeme
- Atemschutzsysteme und Zubehör

D

The WALTHER PILOT Programme

- Manual Spray Guns
- Automatic Spray Guns
- Low Pressure Spray Guns (System HVLP)
- Powder Coating Systems
- Material Pressure Tanks
- Nonpressurized Tanks
- Agitator Systems
- Airless Equipment and Transfer Pumps
- Material Circulation Systems
- Combined Spraying and Drying Booths
- Spray Booth with Filter Mats
- Spray Booth with Water-Wash Function
- Powder Spray Stands
- Dryers
- Ventilation Systems
- Protective Respiratory Systems and Accessory Items

GB

Le Programme de WALTHER PILOT

- Pistolets de pulvérisation manuels
- Pistolets de pulvérisation automatiques
- Pistolets de pulvérisation (Système HVLP)
- Systèmes de poudrage
- Réservoirs sous pression
- Récipients de mélange et de stockage
- Appareils de pulvérisation sans air
- Pompes de transfert
- Murs à aspiration sèche
- Murs à rideau d'eau
- Cabines de poudrage
- Cabines mixtes peinture-séchage
- Installations de soufflage
- Etuves
- Très nombreux accessoires

F

Het WALTHER PILOT Programma

- Manuele spuitpistolen
- Automatische spuitpistolen
- Lagedruk-spuitpistolen (systeem HVLP)
- Poederspoitinstallaties
- Airless apparaten en vloeistofpompen
- Druktanks
- Drukloze tanks
- Circulatiesystemen
- Roersystemen
- Gecombineerd spuit- en droogboxen
- Verfnevelafzuigsystemen met droge afscheiding
- Verfnevelafzuigsystemen met natte afscheiding
- Verluchttingsinstallaties
- Allerlei accessoires

NL



Die Beschichtungs-Experten

WALTHER Spritz- und Lackiersysteme GmbH
Kärntner Str. 18-30 • D-42327 Wuppertal
Tel.: 0202 / 787-0 • Fax: 0202 / 787-2217
www.walther-pilot.de
E-mail: info@walther-pilot.de

